

PLAN VIEW OF TURNTABLE  
CENTER SECTION WELD

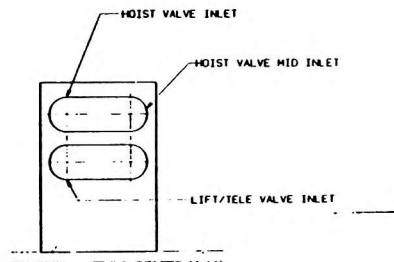

VIEW E-E

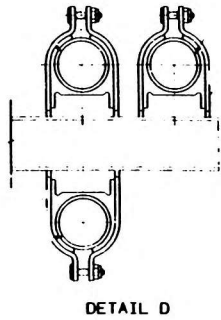

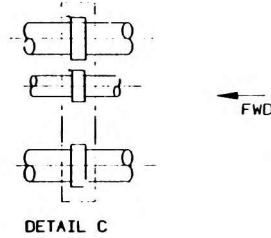
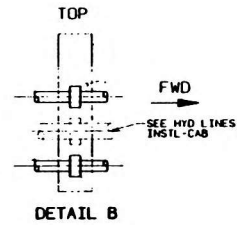
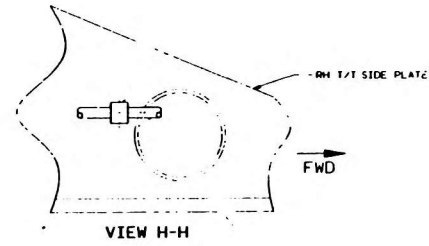
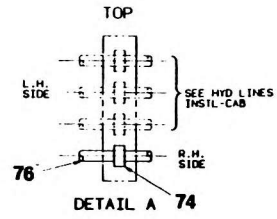
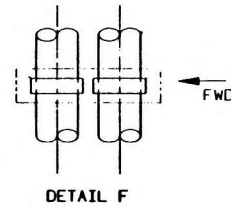
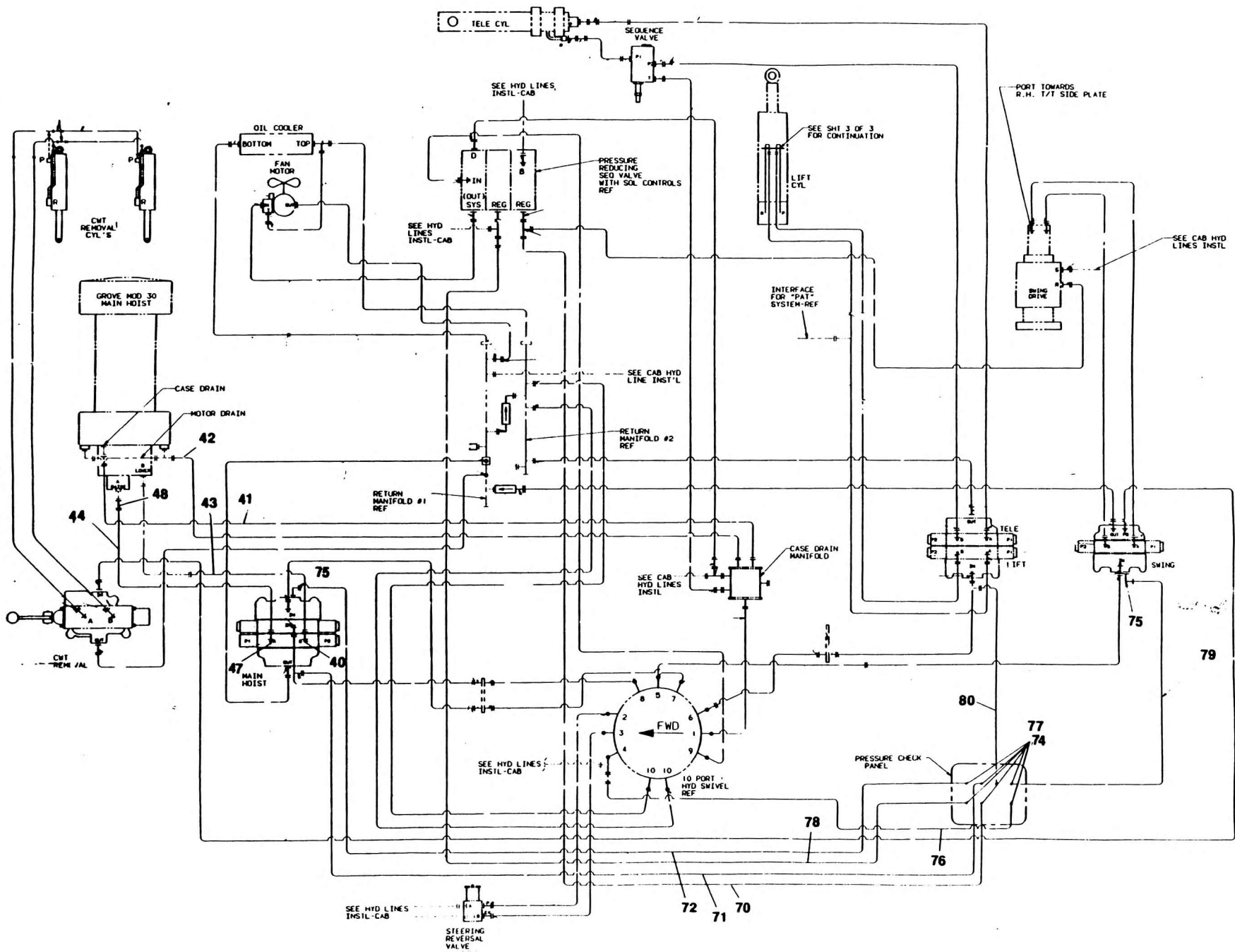

72 71 70

76

78

77 74

79

80

SEE HYD LINES INSTL-CAB

STEERING REVERSAL VALVE

SEE HYD LINES INSTL-CAB

10 PORT HYD SWIVEL REF

PRESSURE CHECK PANEL

SEE CAB HYD LINES INSTL

CASE DRAIN MANIFOLD

RETURN MANIFOLD #1 REF

RETURN MANIFOLD #2 REF

SEE CAB HYD LINE INST'L

SEE HYD LINES INSTL-CAB

PRESSURE REDUCING SED VALVE WITH SOL CONTROLS REF

SEE HYD LINES INSTL-CAB

SEE SH1 3 OF 3 FOR CONTINUATION

PORT TOWARDS R.H. 1/2 SIDE PLATE

SEE CAB HYD LINES INSTL

GROVE MOD 30 MAIN HOIST

CASE DRAIN

MOTOR DRAIN

44

43

41

75

47

40

44

43

41

44

43

41

44

43

41

44

43

41

44

43

41

44

43

41

44

43

41

44

43

41

44

43

41

44

43

41

44

43

41

44

43

41

44

43

41

44

43

41

44

43

41

44

43

41